



MIC33050

4MHz Internal Inductor PWM Buck Regulator with HyperLight Load™

General Description

The Micrel MIC33050 is a high efficiency 500mA PWM synchronous buck (step-down) regulator with internal inductor featuring HyperLight Load™, a patent-pending switching scheme that offers best-in-class light load efficiency and transient performance while providing very small external components and low output ripple at all loads.

The MIC33050 also has a very low typical quiescent current draw of 20µA and can achieve over 83% efficiency even at 1mA.

In contrast to traditional light load schemes, the HyperLight Load™ architecture does not trade off control speed to obtain low standby currents and in doing so, the device only needs a small output capacitor to absorb the load transient as the powered device goes from light load to full load.

At higher loads, the MIC33050 provides a constant switching frequency of greater than 4MHz while providing peak efficiencies greater than 93%.

The MIC33050 comes in fixed output voltage options from 0.72V to 2.5V thereby eliminating external feedback components.

The MIC33050 is available in an 12-pin 3mm x 3mm MLF® with a junction operating range of -40°C to +125°C.

Data sheets and support documentation can be found on Micrel's web site at: www.micrel.com.

Features

- Input voltage: 2.7V to 5.5V
- 500mA output current
- Fixed output voltage options from 0.72V to 2.5V
- No external inductor required
- Ultra fast transient response
- 20µA typical quiescent current
- 4MHz in PWM in constant current mode
- Low voltage output ripple
 - 25mVpp in HyperLight Load™ mode
 - 3mV output voltage ripple in full PWM mode
- >93% efficiency
- >83% at 1mA
- Micropower shutdown
- 3mm x 3mm MLF®-12L
- -40°C to +125°C junction temperature range



HyperLight Load™

Applications

- Cellular phones
- Digital cameras
- Portable media players
- Wireless LAN cards
- WiFi/WiMax/WiBro modules
- USB Powered Devices

Typical Application

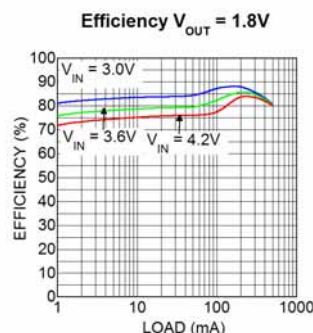
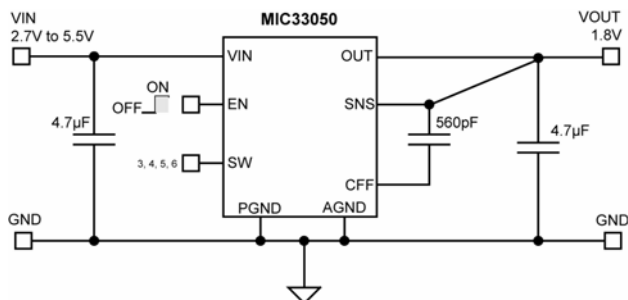

HyperLight Load is a trademark of Micrel, Inc.
MLF and MicroLeadFrame are registered trademarks of Amkor Technology, Inc.

Micrel Inc. • 2180 Fortune Drive • San Jose, CA 95131 • USA • tel +1 (408) 944-0800 • fax + 1 (408) 474-1000 • <http://www.micrel.com>

Ordering Information

Part Number	Voltage	Temperature Range	Package	Lead Finish
MIC33050-4YHL	1.2V	-40° to +125°C	12-Pin 3mm x 3mm MLF [®]	Pb-Free
MIC33050-GYHL	1.8V	-40° to +125°C	12-Pin 3mm x 3mm MLF [®]	Pb-Free

Note:

1. Other voltage options available. Contact Micrel for details.

Pin Configuration

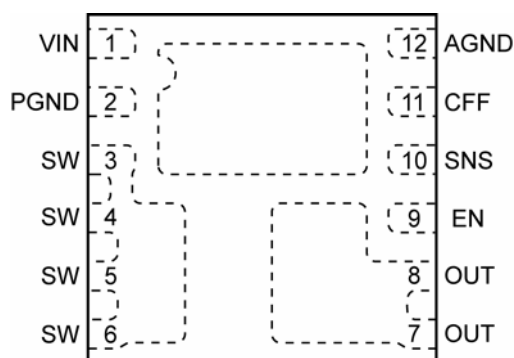

12-Pin 3mm x 3mm MLF[®] (ML)

Pin Description

Pin Number	Pin Name	Pin Function
1	VIN	Supply Voltage (Input): Requires bypass capacitor-to-GND.
9	EN	Enable (Input): Logic low will shut down the device, reducing the quiescent current to less than 4 μ A.
10	SNS	Input to the error amplifier, connect to the external resistor divider network to set the output voltage. For fixed output voltages connect to V _{OUT} and an internal resistor network sets the output voltage.
11	CFF	Feed forward Capacitor connected to Out sense pin
2	PGND	Power Ground
12	AGND	Analog ground
3,4,5,6	SW	Switch (Output): Internal power MOSFET output switches.
7,8	OUT	Output after the internal inductor

Absolute Maximum Ratings⁽¹⁾

Supply Voltage (V_{IN}).....	6V
Output Switch Voltage (V_{SW}).....	6V
Output Switch Current (I_{SW}).....	2A
Logic Input Voltage (V_{EN})	-0.3V to V_{IN}
Storage Temperature Range (T_s).....	-65°C to +150°C
ESD Rating ⁽³⁾	3kV

Operating Ratings⁽²⁾

Supply Voltage (V_{IN}).....	2.7V to 5.5V
Logic Input Voltage (V_{EN}).....	-0.3V to V_{IN}
Junction Temperature (T_J)	-40°C ≤ T_J ≤ +125°C
Thermal Resistance	
3mm x 3mm MLF [®] -12 (θ_{JA}).....	60°C/W

Electrical Characteristics⁽⁴⁾

$T_A = 25^\circ\text{C}$ with $V_{IN} = V_{EN} = 3.6\text{V}$; $C_{FF} = 560\text{pF}$; $C_{OUT} = 4.7\mu\text{F}$; $I_{OUT} = 20\text{mA}$ unless otherwise specified.

Bold values indicate $-40^\circ\text{C} \leq T_J \leq +125^\circ\text{C}$.

Parameter	Condition	Min	Typ	Max	Units
Supply Voltage Range		2.7		5.5	V
Under-Voltage Lockout Threshold	(turn-on)	2.45	2.55	2.65	V
UVLO Hysteresis			100		mV
Quiescent Current, Hyper LL mode	$I_{OUT} = 0\text{mA}$, $V_{SNS} > 1.2 \cdot V_{OUT}$ nominal		20	32	μA
Shutdown Current	$V_{IN} = 5.5\text{V}$; $V_{EN} = 0\text{V}$;		0.01	4	μA
Output Voltage Accuracy	$V_{IN} = 3.0\text{V}$, $I_{LOAD} = 20\text{mA}$	-2.5		+2.5	%
Current Limit in PWM Mode	$SNS = 0.9 \cdot V_{NOM}$	0.65	1	1.7	A
Output Voltage Line Regulation	$V_{IN} = 3.0\text{V}$ to 5.5V , $I_{LOAD} = 20\text{mA}$		0.5		%/V
Output Voltage Load Regulation	$20\text{mA} < I_{LOAD} < 500\text{mA}$,		0.3		%
Maximum Duty Cycle	$SNS \leq V_{NOM}$	80	89		%
PWM Switch ON-Resistance	$I_{SW} = 100\text{mA}$ PMOS $I_{SW} = -100\text{mA}$ NMOS		0.45 0.5		Ω Ω
Frequency	$I_{LOAD} = 120\text{mA}$	3.4	4	4.6	MHz
Soft Start Time	$V_{OUT} = 90\%$		650		μs
Enable Threshold	(turn-on)	0.5	0.8	1.2	V
Enable Hysteresis			35		mV
Enable Input Current			0.1	2	μA
Over-temperature Shutdown			165		$^\circ\text{C}$
Over-temperature Shutdown Hysteresis			20		$^\circ\text{C}$

Notes:

- Exceeding the absolute maximum rating may damage the device.
- The device is not guaranteed to function outside its operating rating.
- Devices are ESD sensitive. Handling precautions recommended. Human body model, 1.5k Ω in series with 100pF.
- Specification for packaged product only.

Typical Characteristics

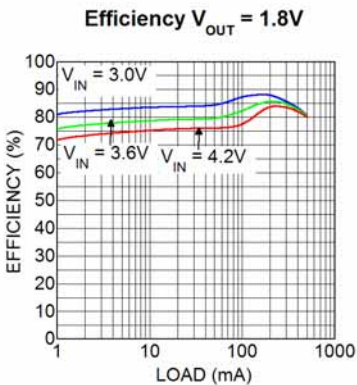
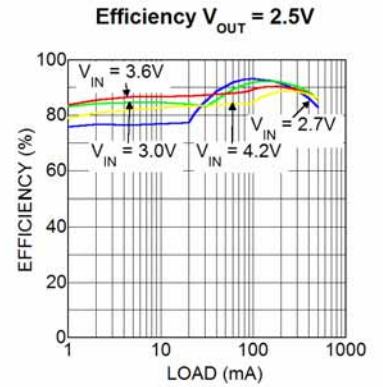
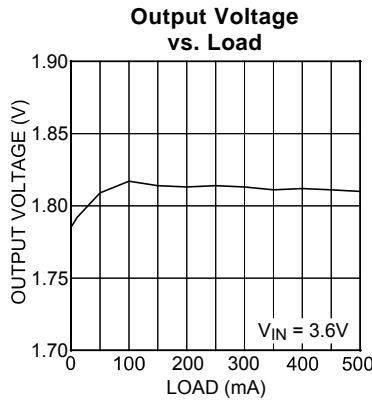
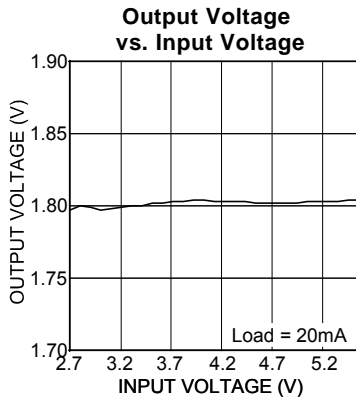
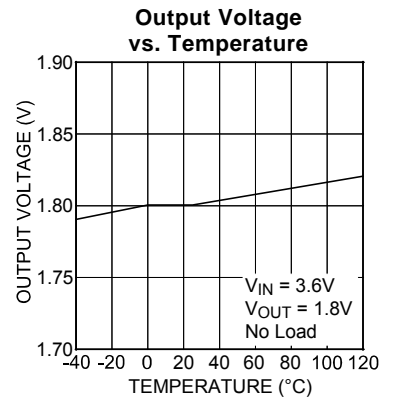
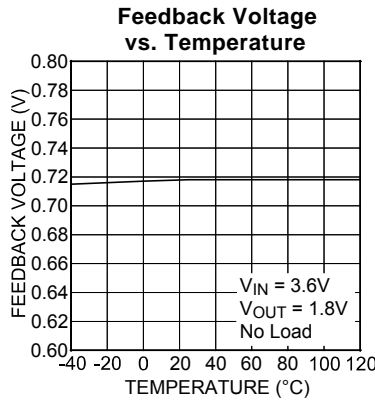
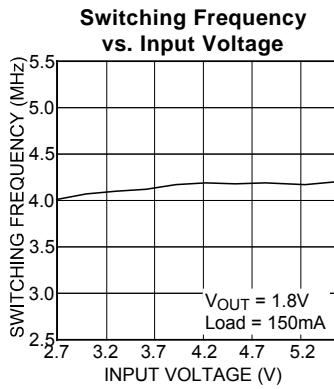
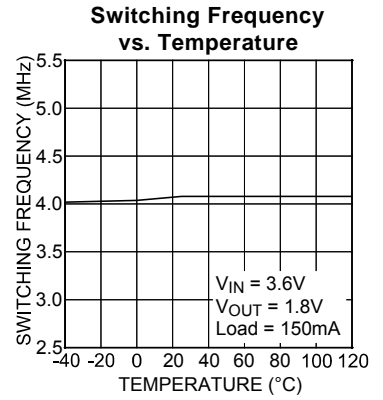
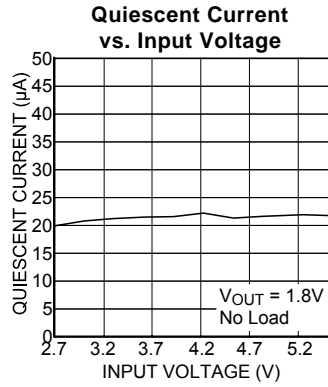
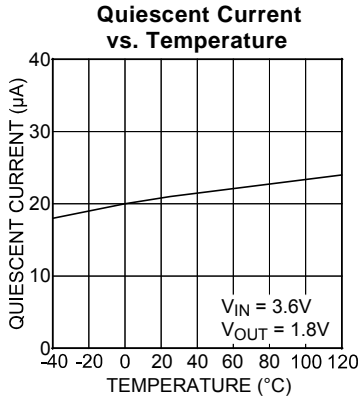

Functional Characteristics

Switching Waveform

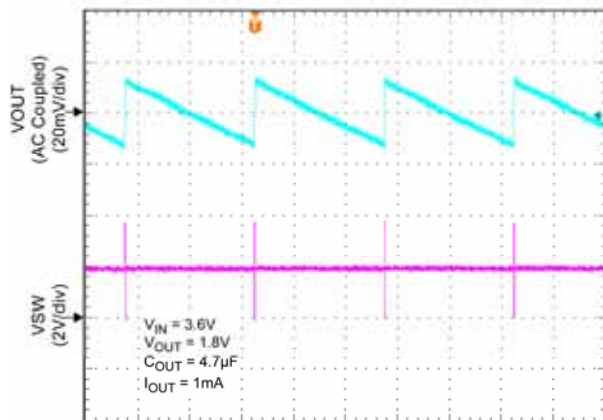

Time (40µs/div)

Switching Waveform

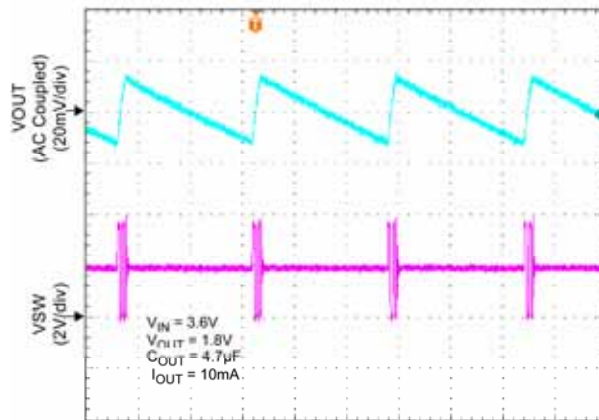

Time (4µs/div)

Switching Waveform

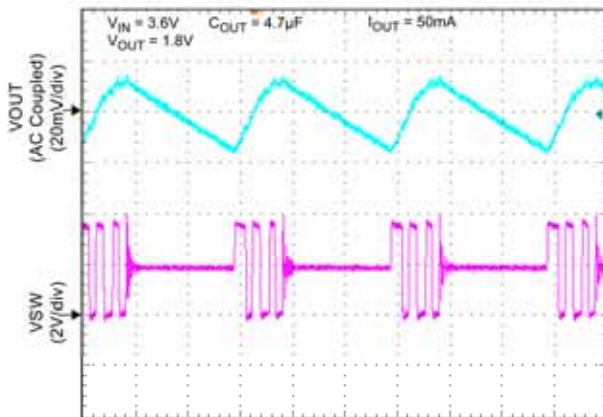

Time (1µs/div)

Switching Waveform

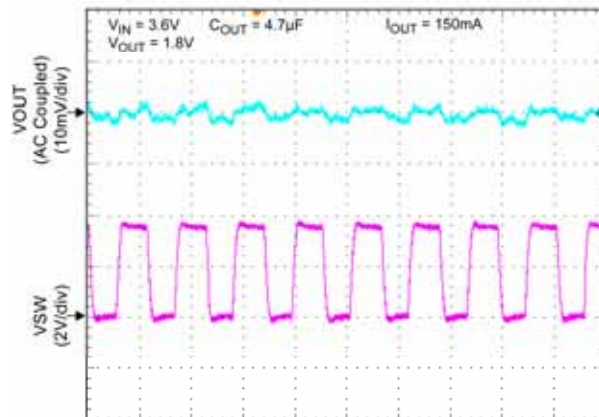

Time (200ns/div)

Switching Waveform

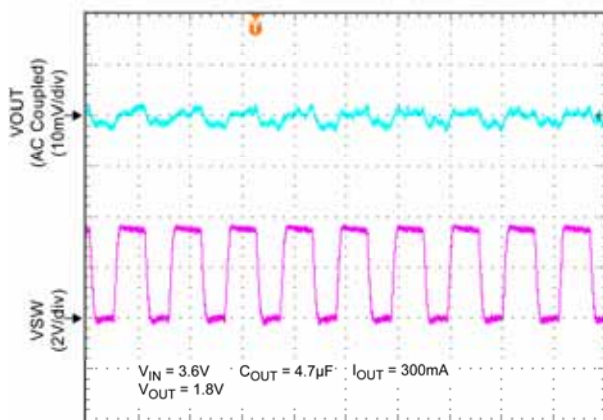

Time (200ns/div)

Switching Waveform

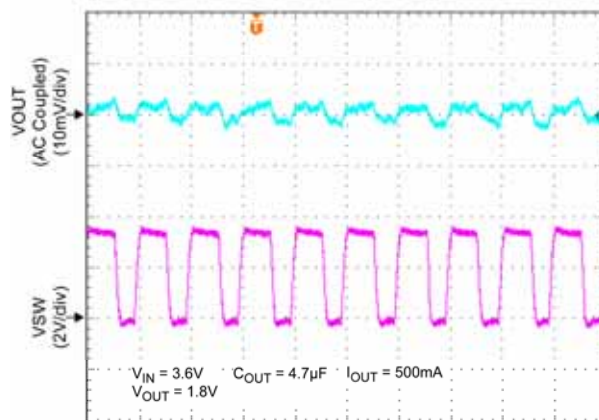

Time (200ns/div)

Functional Characteristics (continued)

Start-Up

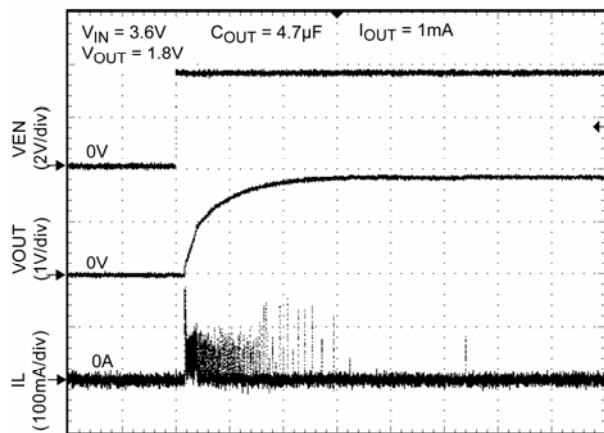

Time (400µs/div)

Load Transient

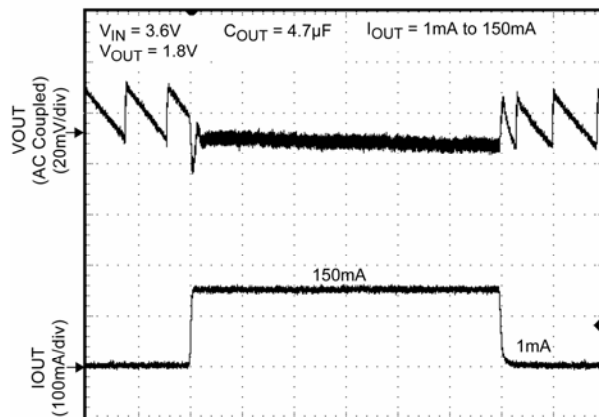

Time (20µs/div)

Start-Up

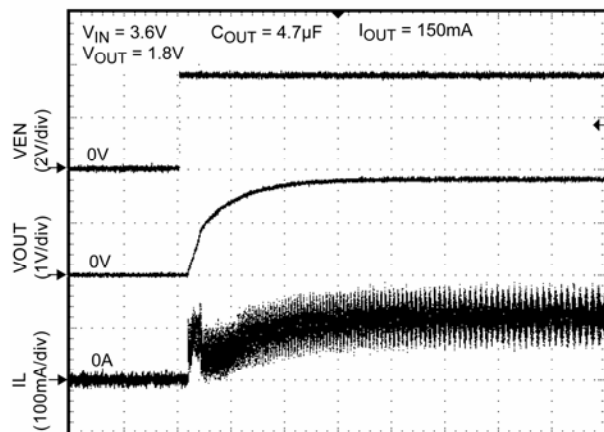

Time (400µs/div)

Load Transient

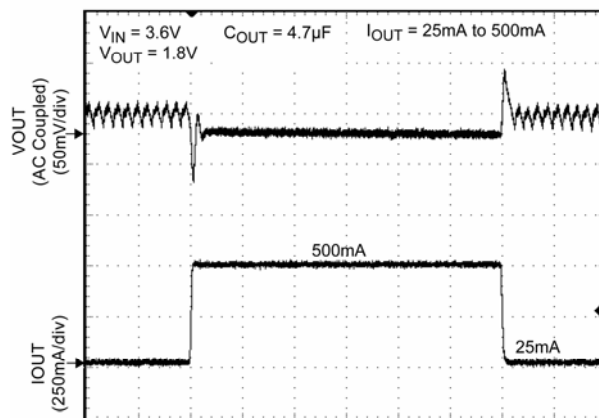

Time (20µs/div)

Functional Diagram

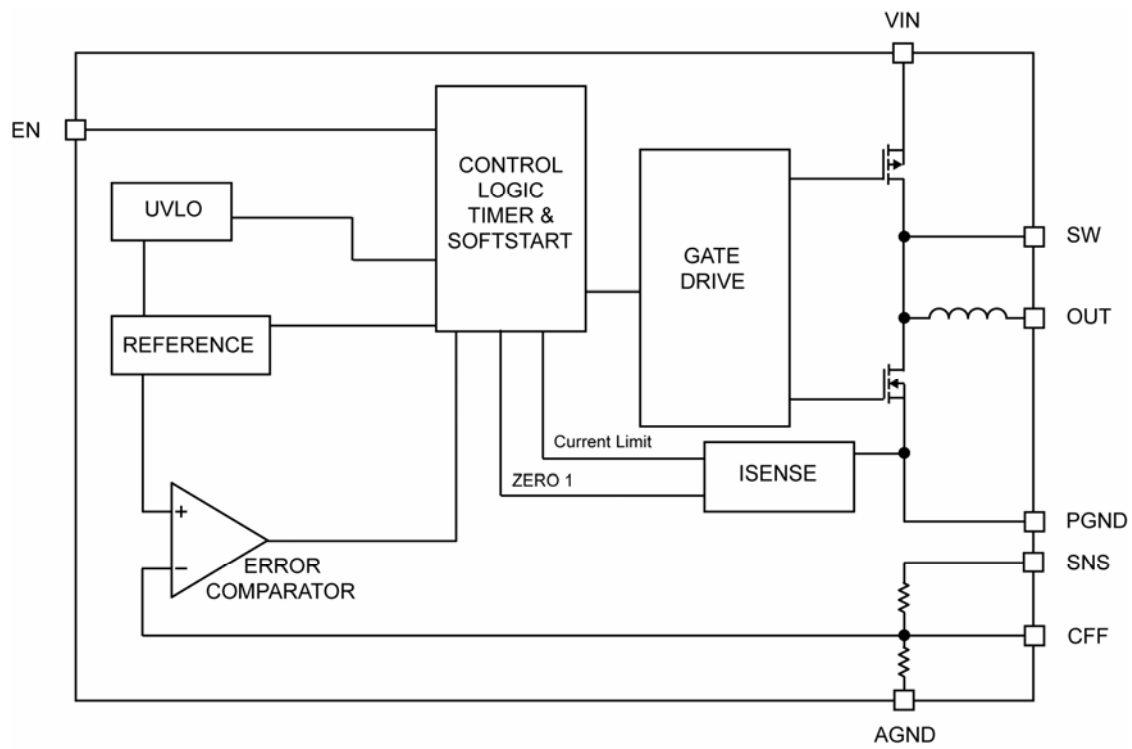

MIC33050 Simplified Block Diagram

Functional Description

VIN

VIN provides power to the MOSFETs for the switch mode regulator section and to the analog supply circuitry. Due to the high switching speeds, it is recommended that a 2.2 μ F or greater capacitor be placed close to VIN and the power ground (PGND) pin for bypassing. Refer to the layout recommendations for details.

EN

The enable pin (EN) controls the on and off state of the device. A high logic on the enable pin activates the regulator, while a low logic deactivates it. MIC33050 features built-in soft-start circuitry that reduces in-rush current and prevents the output voltage from overshooting at start up.

SW

The switch (SW) pin connects directly to the inductor and provides the switching current necessary to operate in PWM mode. Due to the high speed switching on this pin, the switch node should be routed away from sensitive nodes such as the CFF pin.

OUT

The output pin (OUT) is the output voltage pin following the internal inductor of the device. Connect an output filter capacitor equal to 2.2 μ F or greater to this pin.

SNS

The SNS pin is needed to sense the output voltage at the output filter capacitor. In order for the control loop to monitor the output voltage accurately it is good practice to sense the output voltage at the positive side the output filter capacitor where voltage ripple is smallest.

CFF

The CFF pin is connected to the SNS pin of MIC33050 with a feed-forward capacitor of 560pF. The CFF pin itself is compared with the internal reference voltage (V_{REF}) of the device and provides the control path to control the output. V_{REF} is equal to 0.72V. The CFF pin is sensitive to noise and should be placed away from the SW pin. Refer to the layout recommendations for details.

PGND

Power ground (PGND) is the ground path for the high current PWM mode. The current loop for the power ground should be as small as possible and separate from the Analog ground (AGND) loop. Refer to the layout recommendations for more details.

AGND

Signal ground (AGND) is the ground path for the biasing and control circuitry. The current loop for the signal ground should be separate from the Power ground (PGND) loop. Refer to the layout recommendations for more details.

Applications Information

Input Capacitor

A minimum of 2.2µF ceramic capacitor should be placed close to the VIN pin and PGND pin for bypassing. X5R or X7R dielectrics are recommended for the input capacitor. Y5V dielectrics, aside from losing most of their capacitance over temperature, they also become resistive at high frequencies. This reduces their ability to filter out high frequency noise.

Output Capacitor

The MIC33050 was designed for use with a 2.2µF or greater ceramic output capacitor. A low equivalent series resistance (ESR) ceramic output capacitor either X7R or X5R is recommended. Y5V and Z5U dielectric capacitors, aside from the undesirable effect of their wide variation in capacitance over temperature, become resistive at high frequencies.

Compensation

The MIC33050 is designed to be stable with an internal inductor with a minimum of 2.2µF ceramic (X5R) output capacitor.

Efficiency Considerations

Efficiency is defined as the amount of useful output power, divided by the amount of power supplied.

$$\text{Efficiency}_{\%} = \left(\frac{V_{\text{OUT}} \times I_{\text{OUT}}}{V_{\text{IN}} \times I_{\text{IN}}} \right) \times 100$$

Maintaining high efficiency serves two purposes. It reduces power dissipation in the power supply, reducing the need for heat sinks and thermal design considerations and it reduces consumption of current from a battery powered applications. Reduced current draw from a battery increases the devices operating time and is critical in hand held devices.

There are two types of losses in switching converters; DC losses and switching losses. DC losses are simply the power dissipation of I^2R . Power is dissipated in the high side switch during the on cycle. Power loss is equal to the high side MOSFET $R_{\text{DS(ON)}}$ multiplied by the Switch Current². During the off cycle, the low side N-channel MOSFET conducts, also dissipating power. Device operating current also reduces efficiency. The product of the quiescent (operating) current and the supply voltage is another DC loss. The current required driving the gates on and off at a constant 4MHz frequency and the switching transitions make up the switching losses.

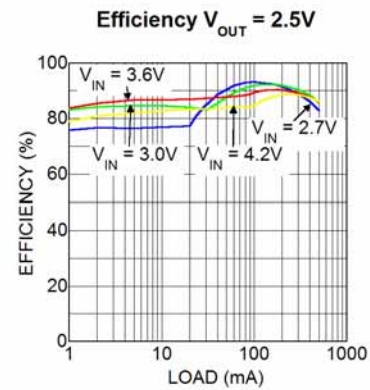

The Figure above shows an efficiency curve. From no load to 100mA, efficiency losses are dominated by quiescent current losses, gate drive and transition losses. By using the HyperLight Load™ mode, the MIC33050 is able to maintain high efficiency at low output currents.

Over 100mA, efficiency loss is dominated by MOSFET RDSON and inductor losses. Higher input supply voltages will increase the Gate-to-Source threshold on the internal MOSFETs, thereby reducing the internal RDSON. This improves efficiency by reducing DC losses in the device. All but the inductor losses are inherent to the device. In which case, inductor selection becomes increasingly critical in efficiency calculations. As the inductors are reduced in size, the DC resistance (DCR) can become quite significant. The DCR losses can be calculated as follows;

$$L_Pd = I_{\text{OUT}}^2 \times \text{DCR}$$

From that, the loss in efficiency due to inductor resistance can be calculated as follows;

$$\text{Efficiency}_{\text{Loss}} = \left[1 - \left(\frac{V_{\text{OUT}} \times I_{\text{OUT}}}{V_{\text{OUT}} \times I_{\text{OUT}} + L_Pd} \right) \right] \times 100$$

Efficiency loss due to DCR is minimal at light loads and gains significance as the load is increased. Inductor selection becomes a trade-off between efficiency and size in this case.

HyperLight Load™ Mode

The MIC33050 uses a minimum on and off time proprietary control loop. When the output voltage falls below the regulation threshold, the error comparator begins a switching cycle that turns the PMOS on and keeps it on for the duration of the minimum-on-time. When the output voltage is over the regulation threshold, the error comparator turns the PMOS off for a minimum-off-time. The NMOS acts as an ideal rectifier that conducts when the PMOS is off. Using a NMOS switch instead of a diode allows for lower voltage drop across the switching device when it is on. The asynchronous switching combination between the PMOS and the NMOS allows the control loop to work in discontinuous mode for light load operations. In discontinuous mode, MIC33050 works in

pulse frequency modulation (PFM) to regulate the output. As the output current increases, the switching frequency increases. This improves the efficiency of the MIC33050 during light load currents. As the load current increases, the MIC33050 goes into continuous conduction mode (CCM) at a constant frequency of 4MHz. The equation to calculate the load when the MIC33050 goes into continuous conduction mode may be approximated by the following formula:

$$I_{\text{LOAD}} = \left(\frac{(V_{\text{IN}} - V_{\text{OUT}}) \times D}{2L \times f} \right)$$

MIC33050 Typical Application Circuit

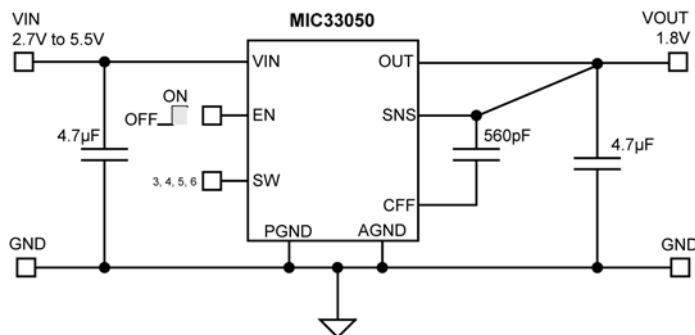

Bill of Materials

Item	Part Number	Manufacturer	Description	Qty
C1, C2	C1608X5R0J476K	TDK ⁽¹⁾	4.7µF Ceramic Capacitor, 6.3V, X5R, Size 0603	2
C3	C1005X5R0J476K	Murata ⁽²⁾	560pF Ceramic Capacitor, 6.3V, X5R, Size 0402	1
U1	MIC33050-4YHL	Micrel, Inc. ⁽⁴⁾	4MHz PWM Buck Regulator with HyperLight Load Mode	1
	MIC33050-GYHL			

Notes:

1. TDK: www.tdk.com
2. Murata: www.murata.com
3. Micrel, Inc: www.micrel.com

PCB Layout Recommendations

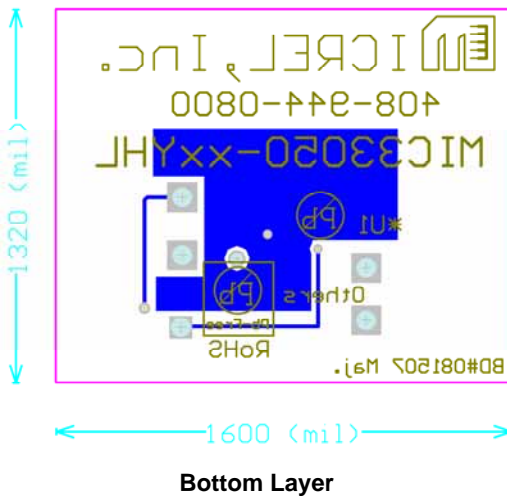
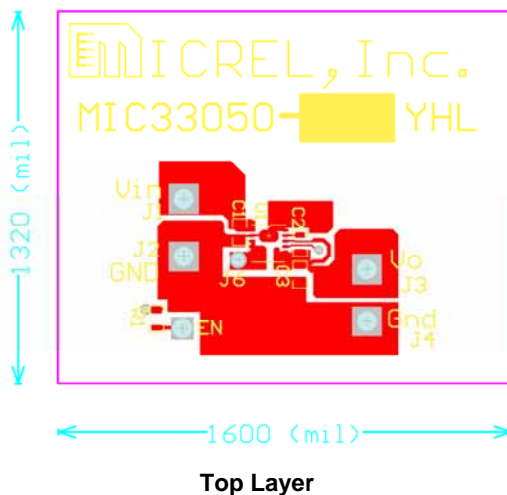

Package Information

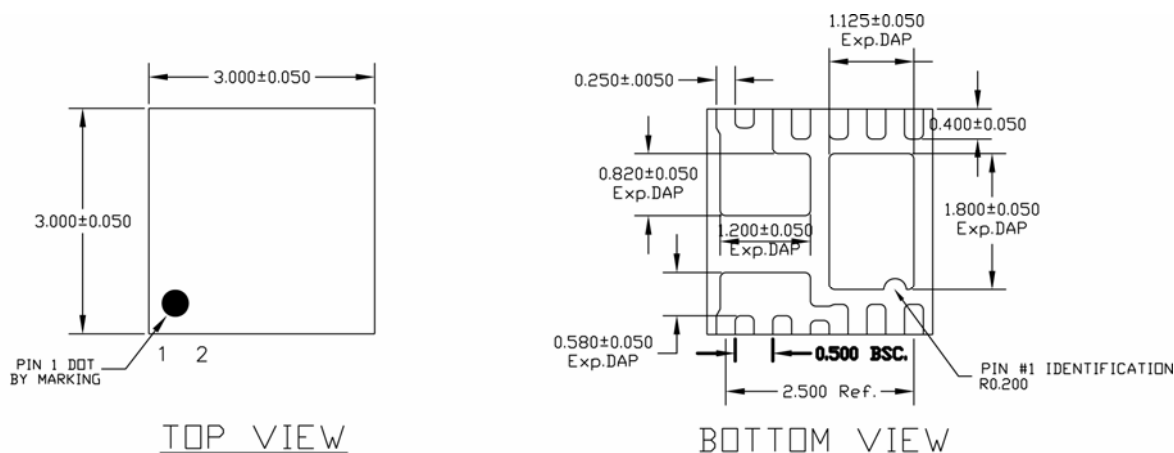

- NOTE:
1. ALL DIMENSIONS ARE IN MILLIMETERS.
 2. MAX. PACKAGE WARPAGE IS 0.05 mm.
 3. MAXIMUM ALLOWABLE BURRS IS 0.076 mm IN ALL DIRECTIONS.
 4. PIN #1 ID ON TOP WILL BE LASER/INK MARKED.
- △ APPLIED ONLY FOR TERMINALS.

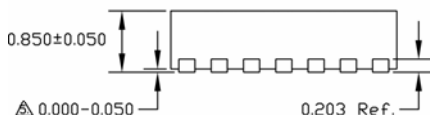

SIDE VIEW

12-Pin 3mm x 3mm MLF[®] (ML)

MICREL, INC. 2180 FORTUNE DRIVE SAN JOSE, CA 95131 USA
 TEL +1 (408) 944-0800 FAX +1 (408) 474-1000 WEB <http://www.micrel.com>

The information furnished by Micrel in this data sheet is believed to be accurate and reliable. However, no responsibility is assumed by Micrel for its use. Micrel reserves the right to change circuitry and specifications at any time without notification to the customer.

Micrel Products are not designed or authorized for use as components in life support appliances, devices or systems where malfunction of a product can reasonably be expected to result in personal injury. Life support devices or systems are devices or systems that (a) are intended for surgical implant into the body or (b) support or sustain life, and whose failure to perform can be reasonably expected to result in a significant injury to the user. A Purchaser's use or sale of Micrel Products for use in life support appliances, devices or systems is a Purchaser's own risk and Purchaser agrees to fully indemnify Micrel for any damages resulting from such use or sale.

© 2007 Micrel, Incorporated.